

Filter elements for installation in Eaton filter housings

Type 17. filter elements

RE 51465

Edition: 2014-04



- ▶ Frame sizes: 60 to 3001
- ▶ Collapse pressure rating: 16 to 250 bar
[232 to 3626 psi]
- ▶ Temperature rating: -30 °C to +100 °C
[-22 to +212 °F]
- ▶ Ratings: 3 µm to 20 µm (DIN 24550 part 2)
- ▶ Filtration ratio: $\beta_{x(c)} > 200$ (ISO 16889)

Features

- ▶ Filter media made of glass fiber material, filter paper, wire mesh, for numerous fields of application
- ▶ Cleanable wire mesh filter media
- ▶ Attainable oil cleanliness up to ISO 12/8/3 (ISO 4406)
- ▶ High dirt holding capacity and filtration performance due to multi-layer glass fiber technology and a low initial pressure differential (ISO 3968)
- ▶ Filter elements with high pressure differential stability

Contents

| | |
|--|----------|
| Features | 1 |
| Ordering code | 2 |
| Configuration possibilities | 3 |
| Function, section | 3 |
| Filter variables | 4 |
| Filter media | 5 ... 10 |
| Installation, commissioning, maintenance | 11 |
| Directives and standards | 11 |
| Exchangeability | 11 |

Ordering code

Filter element type 17.

| | | | | | |
|----|----|----|----|----|----|
| 01 | 02 | 03 | 04 | 05 | 06 |
| 17 | | | - | - | 0 |

Filter element

| | | |
|----|--------|----|
| 01 | Design | 17 |
|----|--------|----|

Size

| | | |
|----|---|-----|
| 02 | According to Eaton size 60, 70, 90, 120, 150, 170, 175, 240, 320, 330, 360, 425, 450, 600, 631, 900, 950, 1201, 2001, 3001 | ... |
|----|---|-----|

Filter rating in µm

| | | | |
|----|-----------------------------|--|----------------------------------|
| 03 | Nominal | Stainless steel wire mesh, cleanable | G10 G25 G40 G60 G100 |
| | | Filter paper, non-reusable (not cleanable) | P10 P25 |
| | Absolute (ISO 16889) | Glass fiber material, non-reusable (not cleanable) | H3XL H6XL H10XL H20XL |

Pressure differential

| | | |
|----|---|-----|
| 04 | Max. pressure differential of the filter element 250 bar [3626 psi] | H00 |
| | Max. pressure differential of the filter element 30 bar [435 psi] | A00 |
| | Max. pressure differential of the filter element 16 bar [232 psi] | G00 |
| | Max. pressure differential of the filter element 10 bar [145 psi] | J00 |

Bypass valve

| | | |
|----|----------------------|---|
| 05 | Without bypass valve | 0 |
|----|----------------------|---|

Seal

| | | |
|----|----------|---|
| 06 | NBR seal | M |
| | FKM seal | V |

Order example:
17.60 H10XL-A00-0-M

Material no.: R928017752

More filter ratings, seal materials as well as an HFC/HFA-resistant version are available upon request.

Filter element search with **Fit4Filter** available as Rexroth App (download at the Apple App Store or Google Play Store) **or** as Rexroth online software at www.boschrexroth.de/filter.

Configuration possibilities

| Size | Pressure differential code letter | | | | Bypass valve (5 = 2.5 bar [36 psi]) optional |
|---------|-----------------------------------|---------------------------|-------------------------|-------------------------|---|
| | A00 30 bar [435 psi] | H00 250 bar [3626 psi] | G00 16 bar [232 psi] | J00 10 bar [145 psi] | |
| 17.60 | ● | ● | | | – |
| 17.70 | | | ● | | ● |
| 17.90 | ● | ● | | | – |
| 17.120 | | | ● | | ● |
| 17.150 | ● | ● | | | – |
| 17.170 | ● | ● | | | – |
| 17.175 | | | ● | | ● |
| 17.210 | | | ● | | ● |
| 17.240 | ● | ● | | | – |
| 17.320 | | | ● | | ● |
| 17.330 | | | ● | | ● |
| 17.360 | ● | ● | | | – |
| 17.425 | | | ● | | ● |
| 17.450 | ● | ● | | | – |
| 17.600 | ● | ● | | | – |
| 17.631 | | | ● | | ● |
| 17.900 | ● | ● | | | – |
| 17.950 | | | | ● | ● |
| 17.2001 | | | | ● | ● |
| 17.3001 | | | | ● | ● |

● = admissible configuration

– = not possible

Function, section

The filter element is the central component of industrial filters. The actual filtration process takes place in the filter element. The applied filter elements and the filter media used in the filter elements determine the major filter variables such as size range of particle retention, dirt holding capacity and pressure loss. Rexroth filter elements are used for the filtration of hydraulic fluids in the hydraulic system as well as for the filtration of lubricants, industrial fluids and gases.

Filter elements consist of a combination of radially pleated filter media (3) which are laid around a perforated support tube (2). Support tube and filter element mat are glued to both end caps (1). Seals are provided between the filter element and the filter housing as a seal.

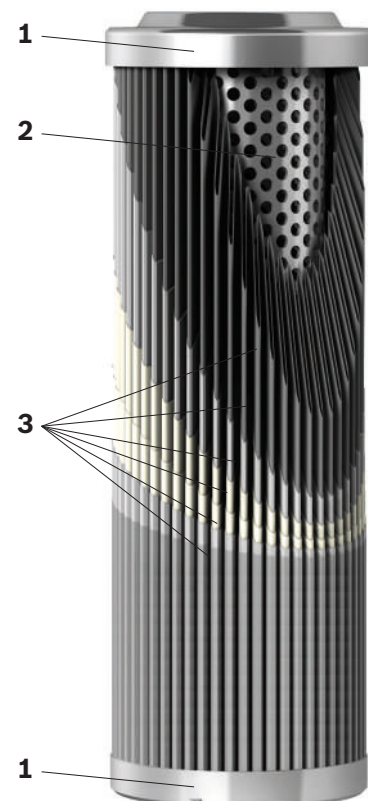

Filter variables

Filter rating and attainable oil cleanliness

The main goal when using industrial filters is not only the direct protection of machine components but to attain the target oil cleanliness. Oil cleanliness is defined on the

basis of oil cleanliness classes which classify how the amount of particles of the existing contamination is distributed in the operating liquid.

Filtration performance

Filtration ratio $\beta_{x(c)}$ (β value)

The retention capacity of hydraulic filters in a hydraulic system is defined by the filtration ratio $\beta_{x(c)}$. This variable is therefore the most important performance characteristic of a hydraulic filter. It is measured in the multipass test, and is the average value of the specified initial and final pressure differential according to ISO 16889 using ISOMTD test dust.

The filtration ratio $\beta_{x(c)}$ is defined as the ratio of the particle count of the respective particle size on both sides of the filter.

Dirt holding capacity

It is also measured using the multipass test and determines the amount of test dust ISOMTD which is fed to the filter media until a specified pressure differential increase has been reached.

Pressure loss (also pressure differential or delta p)

The pressure loss of the filter element is the relevant characteristic value for the determination of the filter size. The pressure loss with a clean filter element is recommended by the filter manufacturer or defined by the system manufacturer.

This characteristic value depends on many factors. Mainly: The rating of the filter media, its geometry and arrangement in the filter element, the filter area, the operating viscosity of the fluid and the flow.

The term "delta p" is often also expressed with the symbol " Δp ".

When dimensioning the filter, an initial pressure loss is determined which must not be exceeded by the new filter element based on the aforementioned conditions.

The following diagram shows the typical pressure loss behavior of filter elements with different filter media at different flows for a viscosity of 30 mm²/s [150 SUS].

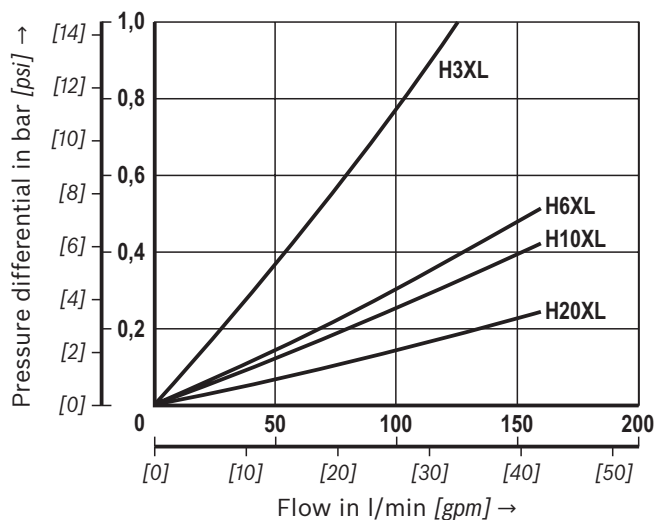
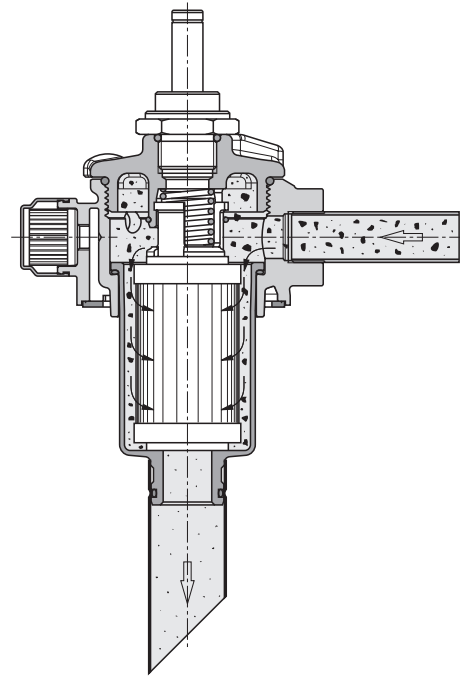

Filter media

Overview

Depending on the application and requirements, different filter media in different filtration ratings are used for the separation of particles.

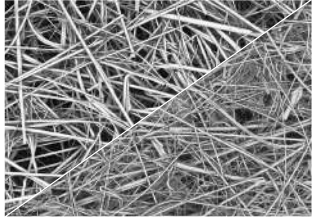
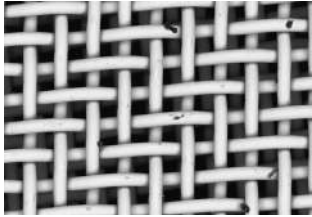
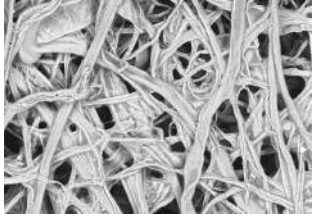
| Filter media/set-up | Electron microscope image |
|---|--|
| <p>H...XL, glass fiber material Depth filter, combination of inorganic micro glass filter media. High dirt holding capacity due to multi-layer technology.</p> |  |
| <p>G..., stainless steel wire mesh material 1.4401 or 1.4571 Surface filter made of stainless steel wire mesh with supporting layer.</p> |  |
| <p>P..., filter paper Inexpensive depth filter made of filter paper with supporting layer. Made of specially impregnated cellulose fiber preventing humidity and swelling.</p> |  |

Technical data

(For applications outside these parameters, please consult us!)

| general | | |
|-----------------------------------|----------------|---|
| Filtration direction | | From the outside to the inside |
| Ambient temperature range | °C [°F] | -30 ... +65 [-22 ... +149] |
| Material | - Cover/base | Steel, aluminum or plastic (depending on the version) |
| | - Support tube | Steel |
| | - Seals | NBR or FKM |
| hydraulic | | |
| Hydraulic fluid temperature range | °C [°F] | -20 ... +100 [-4 ... +212] |
| Minimum conductivity of the media | pS/m | 300 |

Compatibility with permitted hydraulic fluids

| Hydraulic fluid | Classification | Suitable sealing materials | Standards |
|-----------------|----------------|----------------------------|-----------|
| Mineral oil | HLP | NBR | DIN 51524 |

**Important information on hydraulic fluids!**

► For more information and data on the use of other hydraulic fluids, please refer to data sheet 90220 or contact us!

► HFC/HFA and other hydraulic special fluids upon request.

Filter media

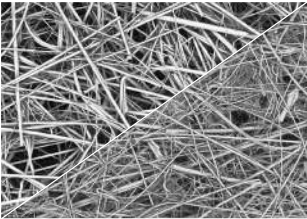
| Technical data | H...XL |
|---|---|
| <p>Glass fiber material, H...XL</p> <p>This filter media achieves the best possible cleanliness level when compared to other filter media. It is suitable for fluids such as hydraulic oils, lubricants, chemical and industrial liquids. Due to its defined dirt holding capacity (ISO 16889), it offers highly effective protection for machines and system components which are sensitive to contamination.</p> <ul style="list-style-type: none"> - H...XL depth filter made of inorganic glass fiber material - Absolute filtration/defined retention capacity according to ISO 16889 - High dirt holding capacity due to multi-layer set-up - Non-reusable filter (not cleanable due to the depth filter effect) - Attainable oil cleanliness classes according to ISO 4406 up to ISO code 13/10/8 and better |  |
| <p>Filter rating and attainable oil cleanliness</p> <p>The following table provides recommendations for the selection of a filter media in dependency of the application and indicates the average oil cleanliness class attainable according to ISO 4406 or SAE-AS 4059.</p> | |

Glass fiber material

| Contamination class DIN ISO 4406 | To be achieved with filter | | | Hydraulic system |
|-------------------------------------|----------------------------|--------------------------------|---------------------------------|-----------------------------|
| | $\beta_{x(c)} = 200$ | Material | Arrangement | |
| 13/10/8 ... 17/13/10 | 3 μm | Glass fiber material H...XL | Pressure filter | Servo valves |
| 15/12/10 ... 19/14/11 | 6 μm | | | High-response valves |
| 17/14/10 ... 21/16/13 | 10 μm | | Return flow or pressure filters | Proportional valves |
| 19/16/12 ... 22/17/14 | 20 μm | | | Pumps and valves in general |

Attainable filtration ratio $\beta_{x(c)}$ (β value)

Typical β values of up to 2.2 bar [31.9 psi] Δp pressure increase at the filter element ¹⁾

| Filter media | Particle size "x" for different β values, measurement according to ISO 16889 | | |
|--------------|--|-------------------------|--------------------------|
| | $\beta_{x(c)} \geq 75$ | $\beta_{x(c)} \geq 200$ | $\beta_{x(c)} \geq 1000$ |
| H3XL | 4.0 $\mu\text{m}(c)$ | < 4.5 $\mu\text{m}(c)$ | 5.0 $\mu\text{m}(c)$ |
| H6XL | 4.8 $\mu\text{m}(c)$ | 5.5 $\mu\text{m}(c)$ | 7.5 $\mu\text{m}(c)$ |
| H10XL | 6.5 $\mu\text{m}(c)$ | 7.5 $\mu\text{m}(c)$ | 9.5 $\mu\text{m}(c)$ |
| H20XL | 18.5 $\mu\text{m}(c)$ | 20.0 $\mu\text{m}(c)$ | 22.0 $\mu\text{m}(c)$ |

¹⁾ Filtration ratio $\beta_{x(c)}$ for other filter media upon request

Filtration ratio $\beta_{x(c)}$
as a function of particle size $\mu\text{m}(c)$

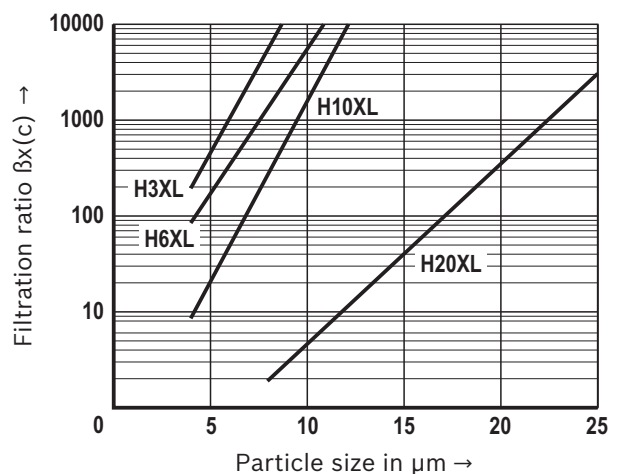

Filter media

Technical data

H...XL

Dirt holding capacity

Compared to conventional filter media with single layer technology, the H...XL filter material features a high dirt holding capacity because it is made of two separate filter layers connected in series.

Conventional filter element - - - -
(single-layer glass fiber material)

Rexroth H...XL filter element ————
(multi-layer glass fiber material)

Superior dirt holding capacity of H...XL filter elements

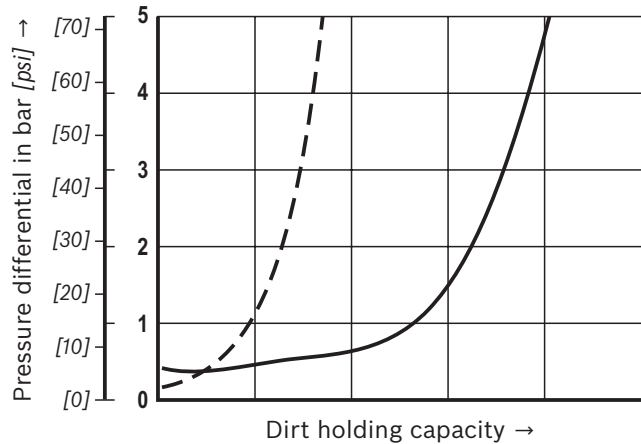

Technical data

G...

Stainless steel wire mesh, G...

There is a comprehensive field of applications for wire mesh filter media. Not only pre-filtration is possible, but also the filtration of lubricating oils, hydraulic oils, coolants and water-like fluids.

- Surface filter made of stainless steel wire mesh
- Reusable, cleanable
- Pleated design, single-, two- or three-layer design

Wire mesh G10 ... G40

As surface filters, these materials are generally cleanable. Due to their fine mesh, however, cleaning is more difficult than with coarser filter mesh.

Therefore, we recommend cleaning the filters in an ultrasonic bath.

Wire mesh G60 ... G100

Due to their coarser mesh size, the cleaning of these filter media is easier.

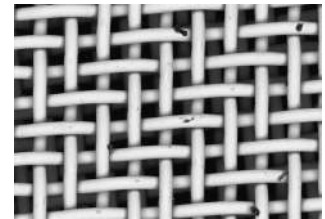

| Filter media | Design | Mesh size |
|---------------------|---------------------|--------------------|
| G10 | Special Dutch weave | 10 µm nom. |
| G25 | Woven mesh | 25 µm nom. |
| G40 | Woven mesh | 40 µm nom. |
| G60 ... G100 | Plain cloth | 60 ... 100 µm nom. |

Filter media

| Technical data | | | | G... |
|--------------------------------------|----------------------------|---------------------------------|--|--|
| Stainless steel wire mesh | | | | |
| Contamination class DIN ISO 4406 | To be achieved with filter | | | Fluid system |
| | Nominal | Material | Arrangement | |
| 20/18/13 ... 21/20/15 | 10 µm | Stainless steel wire mesh, G... | Pressure filter | For existing systems (hydraulics) and as protective filter (G10, G25) For fluids such as: – Lubricants – Petrochemical products – Water – Coolants/thermal oils |
| Cannot be used for wire mesh > 10 µm | 25 ... 100 µm | | Return flow, pressure filters or suction filters | |

Cleaning of filter elements

Cleaning or replacement

Before cleaning a filter element made of wire mesh, it has to be checked after dismantling of the filter element whether it makes sense to clean the element. For example, if the cloth contains many fibrous substances and consists of a material finer than G40, effective and complete cleaning is not possible in many cases. Filter mesh which has visible defects due to frequent cleaning must be replaced. In general, the following applies: The finer the cloth, the thinner the wire. Therefore, especially fine mesh must be cleaned gently to protect the material. The wire mesh must not show any cracks in the folds as otherwise, the filter capacity will be insufficient.

Cleaning frequency

Experience has shown that filter elements made of G10, G25 and G40 can be cleaned up to ten times. Filter mesh > 60 µm can usually be cleaned more than ten times. Reusability, however, very much depends on the type of contamination as well as on the pressure differential during operation (final Δp before dismantling the filter element). For maximum reusability, we therefore recommend replacing in particular the fine mesh at a final Δp of 2.2 bar [31.9 psi] at the latest. Due to the given reasons, the aforementioned values must be regarded as reference values for which we do not assume any liability.

Recommendations for cleaning

Manual and simple cleaning method for filter elements made of wire mesh

| Procedure | Wire mesh G10, G25, G40 | Wire mesh G60 ... G100 |
|-----------------------------------|--|---|
| Chemical pre-cleaning | Let the filter element drain for approx. 1 hour after disassembly. Bathe in solvent afterwards. | |
| Mechanical pre-cleaning | Remove rough dirt with a brush or scrubber. Do not use hard or pointed objects which could damage the filter media. | |
| Mechanical/chemical main cleaning | Put pre-cleaned element in an ultrasonic bath with special solvent. Clean the element in the ultrasonic bath until all visible contamination is removed. | Evaporate with hot washing solution (water with corrosion protection agent) |
| Test | Visually check the material for damage. Replace the filter element if you identify obvious damage. | |
| Preservation | After drying, you must spray the cleaned element with preservative agents and store it sealed against dust in a plastic foil. | |

Filter media

| | |
|-----------------------|-------------|
| Technical data | G... |
|-----------------------|-------------|

Automated cleaning for filter elements made of wire mesh

| Procedure | Wire mesh G10, G25, G40, G60 ... G100 |
|-----------------------------------|--|
| Chemical pre-cleaning | Let the filter element drain for approx. 1 hour after disassembly. Bathe in solvent afterwards. |
| Mechanical/chemical main cleaning | By means of special cleaning systems for filter elements. Most of these systems are provided with a fully automated and combined cleaning mechanism including ultrasound as well as mechanical and chemical cleaning processes. This allows for best possible cleaning results with gentle cleaning processes. |

| | |
|-----------------------|-------------|
| Technical data | P... |
|-----------------------|-------------|

Filter paper, P...

Filter paper is used for the filtration of lubricating oil and for pre-filtration.
Filter paper has the following features:

- Depth filter made of cellulose fibers
- Specially coated to prevent swelling caused by humidity
- Pleated design, single-, two- or three-layer design
- Non-reusable filter (not cleanable due to the depth filter effect)

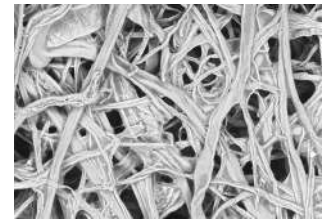

| Filter media | Filtration ratio β values ¹⁾ | Retention rate ¹⁾ |
|--------------|---|------------------------------|
| P10 | $\beta_{10(c)} > 2.0$ | 50 % |
| P25 | $\beta_{10(c)} > 1.25$ | 20 % |

¹⁾ According to ISO 16889

Filter paper

| Contamination class DIN ISO 4406 | To be achieved with filter | | | Hydraulic system |
|-------------------------------------|----------------------------|------------|------------------------------------|----------------------|
| | $\beta_{x(c)} = 200$ | Material | Arrangement | |
| 20/19/14 ... 22/20/15 | 10 μm | Paper P... | Return flow or pressure filters | For existing systems |
| 21/20/15 ... 22/21/16 | 25 μm | | | |

Installation, commissioning, maintenance

When does the filter element have to be replaced or cleaned?

As soon as the dynamic pressure or the pressure differential set at the maintenance indicator is reached, the red button of the optical, mechanical maintenance indicator pops out. If an electronic switching element is provided, an electric signal output is also provided. In this case, the filter element must be replaced or cleaned.

Filter elements should be replaced or cleaned after a max. 6 months.

Notice:

If the maintenance indicator signal is ignored, the increasing pressure differential may damage the filter element causing it to collapse.

Filter element exchange

Detailed instructions with regard to the exchange of filter elements can be found in the data sheet of the relevant filter series.

WARNING!

Filters are containers under pressure. Before opening the filter housing, check whether the system pressure in the filter has been decreased to ambient pressure. Only then may the filter housing be opened for maintenance. Warranty becomes void if the delivered item is changed by the ordering party or third parties or improperly mounted, installed, maintained, repaired, used or exposed to environmental conditions that do not comply with the installation conditions.

Directives and standards

Rexroth filter elements are tested and quality-monitored according to different ISO test standards:

| | |
|--|-------------------|
| Filtration performance test (multipass test) | ISO 16889:2008-06 |
| Δp (pressure loss) characteristic curves | ISO 3968:2001-12 |
| Compatibility with hydraulic fluid | ISO 2943:1998-11 |
| Collapse pressure test | ISO 2941:2009-04 |

The development, manufacture and assembly of Rexroth industrial filters and Rexroth filter elements is carried out within the framework of a certified quality management system in accordance with ISO 9001:2000.

Exchangeability

Rexroth filter elements for installation in Eaton filter housings are exchangeable with regard to their dimensions with the aforementioned competitive filter elements.

They comply with the state-of-the-art in technology and are developed and tested according to specific test procedures such as ISO 16889 (filtration performance test), ISO 2941

(collapse pressure) and ISO3968 (pressure loss).

The Rexroth filter elements recommended by us are exclusively intended for intended applications. They must be maintained regularly and replaced, if necessary.

Notes

Bosch Rexroth AG
Werk Ketsch
Hardtwaldstraße 43
68775 Ketsch, Germany
Phone +49 (0) 62 02 / 6 03-0
filter-support@boschrexroth.de
www.boschrexroth.de

© This document, as well as the data, specifications and other information set forth in it, are the exclusive property of Bosch Rexroth AG. It may not be reproduced or given to third parties without its consent.
The data specified above only serve to describe the product. No statements concerning a certain condition or suitability for a certain application can be derived from our information. The information given does not release the user from the obligation of own judgment and verification. It must be remembered that our products are subject to a natural process of wear and aging.